

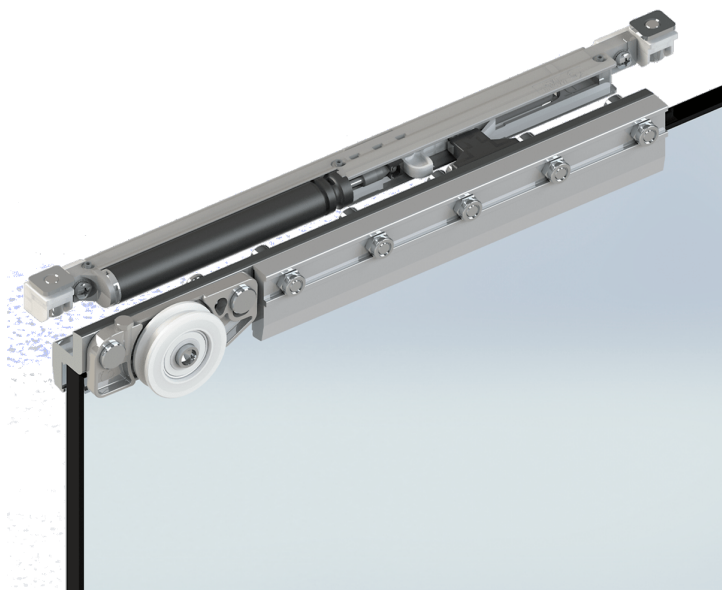





## Micro 50

Concealed sliding elements integrated into profiles with reduced dimensions



 8 ÷ 12,7 mm

 600 ÷ 1600 mm

 Max 80 kg

 Fermi standard

 Fermi ammortizzati



## Micro 50

Concealed sliding system for glass doors, integrated into profiles with reduced dimensions (only 50 mm). No glass drilling required.

**Design and functionality**The innovative Micro 50 system is able to meet current design and load capacity market requirements.

The system, indeed, is equipped with a sliding clamps with totally external adjustment. The sliding clamps, equipped with ball bearings necessary to grant a balanced motion, have been positioned to the door's edges allowing a stable motion even with narrow doors.

**High performances in reduced dimensions**In a space (encumbrance) of only 50 mm, the Micro 50 system integrates bearings able to support a weight of 80 kg. Available both with air-cushioned stops and with standard stops, the system avoids the need of any drilling operations on the glass.

**An "all around" system**The Micro 50 system is suitable for both monolithic and laminated glass, since the clamp used is produced in a particular dimension able to avoid any tension on the glass, which could cause it to break.

The Micro 50 system track is designed to integrate the sliding door with the fixed glass.

